

CLARK

SITS
— comfortable life

cocktail&design



design: Niels Gammelgaard

TECHNICAL SPECIFICATION

PROFILE

COMFORT: standard

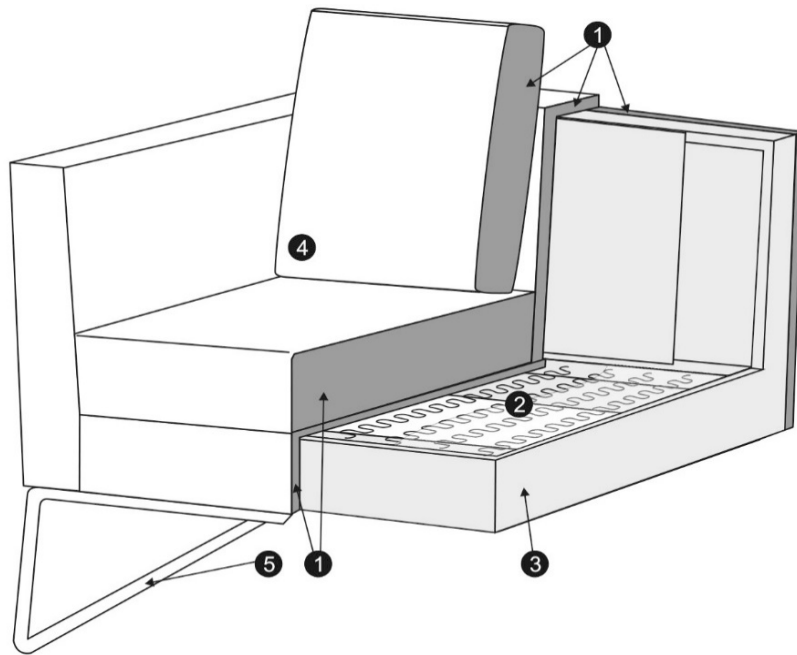

1	polyurethane foam/ high resilient polyurethane foam
2	springs
3	solid wood and wood based elements
4	fabric
5	metal frame (black, grey or chrome)

The producer reserves the right to change construction of products and compnents used due to improving durability of product and customer satisfaction without any further notice.

UPHOLSTERY:

fabric or leather: FC - fix cover, COMFORT: standard

FEET

CHAIR

METAL FRAME:
chrome and painted
black or grey

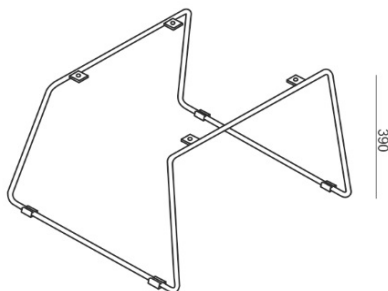

ARMCHAIR, SOFA

METAL FRAME:
chrome and painted
black or grey

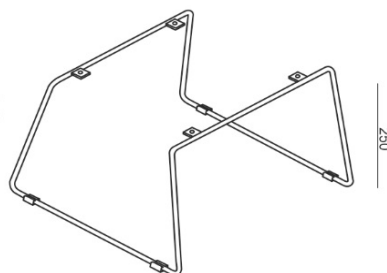

CLARK

cocktail&design



SITS
— comfortable life

design: Niels Gammelgaard

Sales pricelist 2022

UPHOLSTERY: fabric: FC - fix cover COMFORT: standard

Currency: EUR

Valid from: 01.04.2022

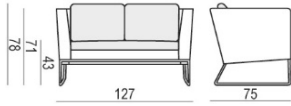
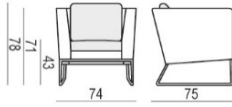
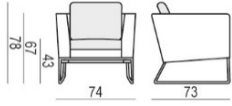
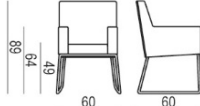
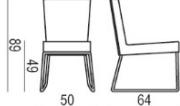
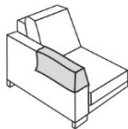
DIMENSION*	DESCRIPTION ARTICLE No	VOL.	WEIGHT	FABRIC USAGE	I	II	III	IV	E
2 seater									
127x75x78/43 	FC E1553-0200-2S	0,90	33	4,8	460 600	490 000	509 600	543 900	681 100
armchair									
74x75x78/43 	FC E1553-0000-2S	0,50	23	3,4	245 000	259 700	289 100	303 800	372 400
armchair low									
74x73x78/43 	FC E1553-0001-2S	0,50	23	3,1	245 000	259 700	289 100	303 800	372 400
chair with armrests									
60x60x89/49 	FC E1553-1501-2S	0,40	15	1,6	181 300	186 200	196 000	205 800	254 800
chair without armrests									
50x64x89/49 	FC E1553-1500-2S	0,40	15	1,1	166 600	171 500	181 300	186 200	225 400
armrest protection / set of 2									
	LC E1553-1900-0	0,01	1	0,7	44 100	53 900	58 800	63 700	88 200

*Explicit +/- 2 cm tolerance of all elements sizes