

POLLY

LUX

SITS
— comfortable life



home&family

design: SITS

TECHNICAL SPECIFICATION

PROFILE

COMFORT: lux

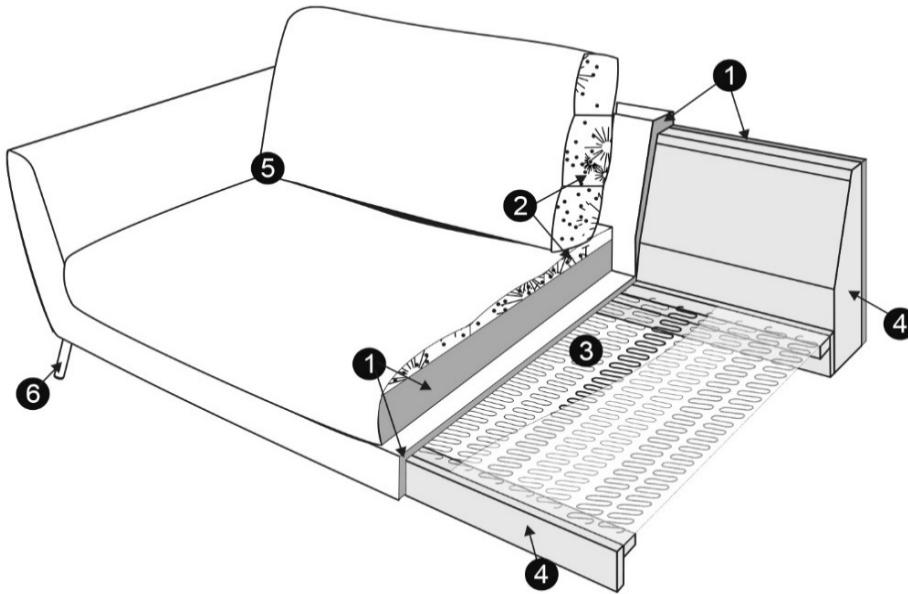

1	polyurethane foam/high resilient polyurethane foam
2	cushion chamber with mix of feather and silicone balls
3	springs
4	solid wood and wood based elements
5	fabric
6	solid wood or metal legs (black, , chrome,)

The producer reserves the right to change construction of products and components used due to improving durability of product and customer satisfaction without any further notice.

UPHOLSTERY:

fabric or leather: FC - fix cover or LCV - loose cover with velcro COMFORT: classic, standard or lux
Explicit: +/- 3 cm tolerance between comfort LUX und STD/CLS in heights

FEET

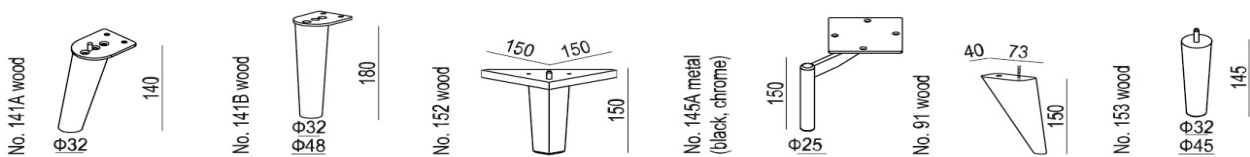

COLOURS OF WOODEN FEET



POLLY
LUX

SITS
— comfortable life



home&family



design: SITS

Sales Pricelist 2024

UPHOLSTERY: fabric: FC - fix cover or LCV - loose cover with velcro
COMFORTS: lux

currency: EUR

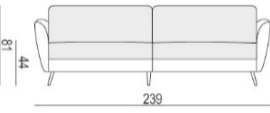
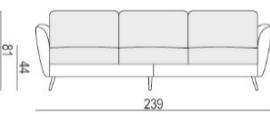
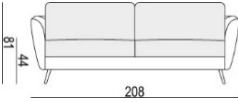
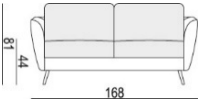
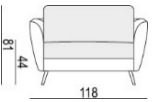
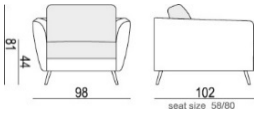
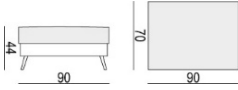
Valid from: 01.02.2024

DIMENSION* with legs H:140mm	DESCRIPTION ARTICLE No	VOL.	WEIGHT	FABRIC USAGE	I	II	III	IV	E	
239x102x81/44										
3 XL seater /two parts, two cushions/										
	FC	E1515-0700-2L	1,37	82	10,6	967 200	1 041 600	1 120 650	1 204 350	1 497 300
	LCV	E1515-0700-4L	1,37	82	10,7	1 064 850	1 148 550	1 232 250	1 325 250	1 650 750
	COVER	E0515-0700-4	0,04	7	10,7	455 700	558 000	655 650	762 600	953 250
239x102x81/44										
3 XL seater /two parts, three cushions/										
	FC	E1515-0702-2L	1,37	82	10,9	1 120 650	1 148 550	1 232 250	1 325 250	1 650 750
	LCV	E1515-0702-4L	1,37	82	10,9	1 171 800	1 264 800	1 357 800	1 460 100	1 813 500
	COVER	E0515-0702-4	0,04	7	10,9	502 200	613 800	730 050	846 300	1 050 900
208x102x81/44										
3 seater										
	FC	E1515-0400-2L	1,46	69	10,1	716 100	776 550	832 350	897 450	1 111 350
	LCV	E1515-0400-4L	1,46	69	10,1	818 400	897 450	953 250	1 023 000	1 283 400
	COVER	E0515-0400-4	0,04	5	10,1	334 800	409 200	483 600	567 300	706 800
168x102x81/44										
2 seater										
	FC	E1515-0200-2L	1,21	54	8,4	627 750	674 250	720 750	776 550	957 900
	LCV	E1515-0200-4L	1,21	54	8,4	716 100	771 900	832 350	897 450	1 111 350
	COVER	E0515-0200-4	0,04	4	8,4	292 950	353 400	427 800	446 400	609 150
118x102x81/44										
armchair wide										
	FC	E1515-0100-2L	0,88	52	6,1	492 900	539 400	571 950	609 150	753 300
	LCV	E1515-0100-4L	0,88	52	6,1	567 300	618 450	655 650	706 800	864 900
	COVER	E0515-0100-4	0,02	3	6,1	232 500	283 650	334 800	353 400	483 600
98x102x81/44										
armchair										
	FC	E1515-0000-2L	0,75	45	5,4	460 350	492 900	534 750	562 650	697 500
	LCV	E1515-0000-4L	0,75	45	5,4	534 750	567 300	609 150	646 350	804 450
	COVER	E0515-0000-4	0,02	3	5,4	218 550	260 400	311 550	330 150	446 400
90x70x44										
footstool										
	FC	E1515-1050-2L	0,27	19	2,5	283 650	292 950	311 550	325 500	409 200
	LCV	E1515-1050-4L	0,27	19	2,5	325 500	344 100	353 400	367 350	460 350
	COVER	E0515-1050-4	0,02	1	2,5	139 500	167 400	186 000	190 650	255 750
77x21x65										
headrest 21/77										
	FC	E1515-2177-4	0,11	2	1,0	55 800	60 450	65 100	69 750	79 050

POLLY

LUX

home&family



SITS
— comfortable life



design: SITS

Sales Pricelist 2024

UPHOLSTERY: fabric: FC - fix cover or LCV - loose cover with velcro
COMFORTS: lux

currency: EUR

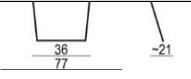
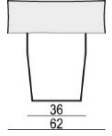
Valid from: 01.02.2024

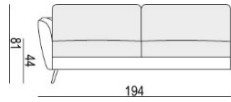
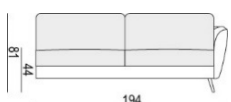
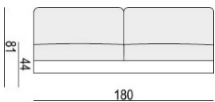
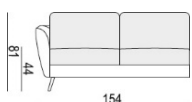
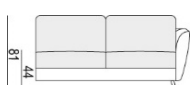
DIMENSION* with legs H:140mm	DESCRIPTION ARTICLE No	VOL.	WEIGHT	FABRIC USAGE	I	II	III	IV	E
	COVER E0515-2177-4	0,01	1	1,0	51 150	51 150	55 800	51 150	55 800
62x21x65	headrest 21/62								
	FC E1515-2162-4	0,09	2	0,9	55 800	60 450	65 100	69 750	79 050
	COVER E0515-2162-4	0,01	1	0,9	51 150	51 150	55 800	51 150	55 800
	armrest protection / set of 2								
	FC E1515-1900-0	0,01	1	0,8	46 500	55 800	60 450	65 100	88 350
elements for building sets:									
194x102x81/44	3 seater left								
	FC E1515-0420-2L	1,31	61	9,0	627 750	678 900	734 700	790 500	985 800
	LCV E1515-0420-4L	1,31	61	9,0	716 100	785 850	841 650	911 400	1 125 300
	COVER E0515-0420-4	0,04	5	9,0	292 950	362 700	432 450	460 350	632 400
194x102x81/44	3 seater right								
	FC E1515-0410-2L	1,31	61	9,0	627 750	678 900	734 700	790 500	985 800
	LCV E1515-0410-4L	1,31	61	9,0	716 100	785 850	841 650	911 400	1 125 300
	COVER E0515-0410-4	0,04	5	9,0	292 950	362 700	432 450	460 350	632 400
180x102x81/44	3 seater without armrests								
	FC E1515-0430-2L	1,16	54	7,7	530 100	567 300	627 750	669 600	837 000
	LCV E1515-0430-4L	1,16	54	7,7	595 200	655 650	711 450	771 900	953 250
	COVER E0515-0430-4	0,04	4	7,7	246 450	297 600	362 700	395 250	534 750
154x102x81/44	2 seater left								
	FC E1515-0220-2L	1,06	46	7,4	534 750	567 300	618 450	660 300	823 050
	LCV E1515-0220-4L	1,06	46	7,4	604 500	655 650	711 450	757 950	948 600
	COVER E0515-0220-4	0,04	4	7,4	246 450	297 600	362 700	385 950	530 100
154x102x81/44	2 seater right								
	FC E1515-0210-2L	1,06	46	7,4	534 750	567 300	618 450	660 300	823 050
	LCV E1515-0210-4L	1,06	46	7,4	604 500	655 650	711 450	757 950	948 600

POLLY

LUX

SITS
— comfortable life

home&family

design: SITS

Sales Pricelist 2024

UPHOLSTERY: fabric: FC - fix cover or LCV - loose cover with velcro
COMFORTS: lux

currency: EUR

Valid from: 01.02.2024

DIMENSION* with legs H:140mm	DESCRIPTION ARTICLE No	VOL.	WEIGHT	FABRIC USAGE	I	II	III	IV	E
154	COVER E0515-0000-4	0,04	4	7,4	246 450	297 600	362 700	385 950	530 100
140x102x81/44	2 seater without armrests								
	FC E1515-0230-2L	0,91	39	6,2	432 450	465 000	511 500	548 700	678 900
	LCV E1515-0230-4L	0,91	39	6,2	492 900	539 400	576 600	632 400	785 850
	COVER E0515-0230-4	0,04	4	6,2	199 950	246 450	297 600	320 850	437 100
104x102x81/44	armchair wide left								
	FC E1515-0120-2L	0,88	45	6,0	492 900	539 400	571 950	609 150	753 300
	LCV E1515-0120-4L	0,88	45	6,0	567 300	618 450	655 650	706 800	864 900
	COVER E0515-0120-4	0,02	3	6,0	232 500	283 650	334 800	353 400	483 600
104x102x81/44	armchair wide right								
	FC E1515-0110-2L	0,88	45	6,0	492 900	539 400	571 950	609 150	753 300
	LCV E1515-0110-4L	0,88	45	6,0	567 300	618 450	655 650	706 800	864 900
	COVER E0515-0110-4	0,02	3	6,0	232 500	283 650	334 800	353 400	483 600
90x102x81/44	armchair wide without armrests								
	FC E1515-0130-2L	0,45	28	4,2	311 550	334 800	367 350	395 250	483 600
	LCV E1515-0130-4L	0,45	28	4,2	353 400	385 950	427 800	446 400	562 650
	COVER E0515-0130-4	0,02	3	4,2	158 100	181 350	218 550	227 850	311 550
84x102x81/44	armchair left								
	FC E1515-0020-2L	0,60	37	4,5	367 350	395 250	427 800	455 700	562 650
	LCV E1515-0020-4L	0,60	37	4,5	427 800	455 700	483 600	525 450	646 350
	COVER E0515-0020-4	0,02	3	4,5	176 700	204 600	246 450	274 350	362 700
84x102x81/44	armchair right								
	FC E1515-0010-2L	0,60	37	4,5	367 350	395 250	427 800	455 700	562 650
	LCV E1515-0010-4L	0,60	37	4,5	427 800	455 700	483 600	525 450	646 350
	COVER E0515-0010-4	0,02	3	4,5	176 700	204 600	246 450	274 350	362 700
70x102x81/44	armchair without armrests								
	FC E1515-0030-2L	0,58	33	3,3	260 400	288 300	311 550	330 150	413 850
	LCV E1515-0030-4L	0,58	33	3,3	306 900	330 150	348 750	372 000	465 000
	COVER E0515-1231-4	0,02	2	3,3	130 200	162 750	181 350	190 650	260 400
102x221x81/44	divan left								

POLLY
LUX

SITS
— comfortable life



home&family

design: SITS

Sales Pricelist 2024

UPHOLSTERY: fabric: FC - fix cover or LCV - loose cover with velcro
COMFORTS: lux

currency: EUR

Valid from: 01.02.2024

DIMENSION* with legs H:140mm	DESCRIPTION ARTICLE No		VOL.	WEIGHT	FABRIC USAGE	I	II	III	IV	E
	FC	E1515-1230-2L	1,39	64	9,1	744 000	804 450	860 250	920 700	1 143 900
	LCV	E1515-1230-4L	1,39	64	9,1	846 300	920 700	995 100	1 055 550	1 315 950
	COVER	E0515-1230-4	0,04	5	9,1	348 750	427 800	492 900	539 400	730 050
divan right										
	FC	E1515-1231-2L	1,39	64	9,1	744 000	804 450	860 250	920 700	1 143 900
	LCV	E1515-1231-4L	1,39	64	9,1	846 300	920 700	995 100	1 055 550	1 315 950
	COVER	E0515-1231-4	0,04	5	9,1	348 750	427 800	492 900	539 400	730 050
chaiselongue wide left										
	FC	E1515-1201-2L	1,12	50	6,1	571 950	618 450	655 650	697 500	860 250
	LCV	E1515-1201-4L	1,12	50	6,1	655 650	706 800	748 650	799 800	995 100
	COVER	E0515-1201-4	0,04	3	6,1	279 000	325 500	381 300	409 200	548 700
chaiselongue wide right										
	FC	E1515-1211-2L	1,12	50	6,1	571 950	618 450	655 650	697 500	860 250
	LCV	E1515-1211-4L	1,12	50	6,1	655 650	706 800	748 650	799 800	995 100
	COVER	E0515-1211-4	0,04	3	6,1	279 000	325 500	381 300	409 200	548 700
chaiselongue left										
	FC	E1515-1200-2L	0,92	44	5,4	530 100	558 000	590 550	627 750	776 550
	LCV	E1515-1200-4L	0,92	44	5,4	595 200	637 050	674 250	716 100	897 450
	COVER	E0515-1200-4	0,04	3	5,4	246 450	292 950	344 100	362 700	488 250
chaiselongue right										
	FC	E1515-1210-2L	0,92	44	5,4	530 100	558 000	590 550	627 750	776 550
	LCV	E1515-1210-4L	0,92	44	5,4	595 200	637 050	674 250	716 100	897 450
	COVER	E0515-1210-4	0,04	3	5,4	246 450	292 950	344 100	362 700	488 250
cozy corner left **										
137/115x180x81/44										

POLLY
LUX

SITS
— comfortable life



home&family

design: SITS

Sales Pricelist 2024

UPHOLSTERY: fabric: FC - fix cover or LCV - loose cover with velcro
COMFORTS: lux

currency: EUR

Valid from: 01.02.2024

DIMENSION* with legs H:140mm	DESCRIPTION ARTICLE No	VOL.	WEIGHT	FABRIC USAGE	I	II	III	IV	E
	FC E1515-1304-2L	1,62	74	10,1	757 950	832 350	897 450	953 250	1 190 400
	LCV E1515-1304-4L	1,62	74	10,1	874 200	948 600	1 023 000	1 102 050	1 367 100
	COVER E0515-1304-4	0,04	6	10,1	353 400	437 100	525 450	558 000	757 950
137/115x180x81/44		cozy corner right **							
	FC E1515-1305-2L	1,62	74	10,1	757 950	832 350	897 450	953 250	1 190 400
	LCV E1515-1305-4L	1,62	74	10,1	874 200	948 600	1 023 000	1 102 050	1 367 100
	COVER E0515-1305-4	0,04	6	10,1	353 400	437 100	525 450	558 000	757 950
97x97x81/44		corner 90° no.1							
	FC E1515-1302-2L	0,59	34	5,0	460 350	492 900	534 750	562 650	697 500
	LCV E1515-1302-4L	0,59	34	5,0	534 750	567 300	604 500	646 350	799 800
	COVER E0515-1302-4	0,02	3	5,0	218 550	260 400	306 900	325 500	441 750
120x120x81/44		corner 90° no.2 **							
	FC E1515-1303-2L	0,90	38	5,3	506 850	544 050	571 950	609 150	753 300
	LCV E1515-1303-4L	0,90	38	5,3	571 950	618 450	660 300	706 800	864 900
	COVER E0515-1303-4	0,02	3	5,3	232 500	288 300	334 800	353 400	483 600
89x99x81/44		corner 30°							
	FC E1515-1300-2L	0,58	27	3,5	460 350	492 900	534 750	562 650	697 500
	LCV E1515-1300-4L	0,58	27	3,5	534 750	567 300	604 500	646 350	799 800
	COVER E0515-1300-4	0,03	3	3,5	218 550	260 400	306 900	325 500	441 750
95x54x4		endpart left							
	FC E1515-1960-2	0,02	4	1,2	79 050	83 700	93 000	97 650	120 900
	LCV E1515-1960-4	0,02	4	1,2	79 050	83 700	93 000	97 650	120 900
95x54x4		endpart right							
	FC E1515-1950-2	0,02	4	1,2	79 050	83 700	93 000	97 650	120 900
	LCV E1515-1950-4	0,02	4	1,2	79 050	83 700	93 000	97 650	120 900

suggested sets:

POLLY
LUX

SITS
— comfortable life



home&family



design: SITS

Sales Pricelist 2024

UPHOLSTERY: fabric: FC - fix cover or LCV - loose cover with velcro
COMFORTS: lux

currency: EUR

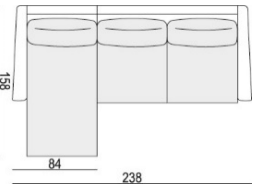
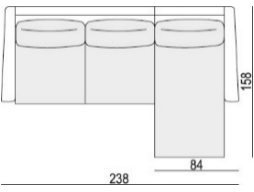
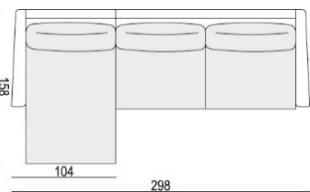
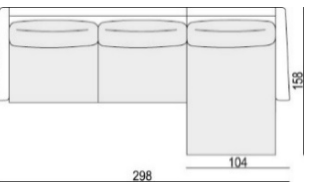
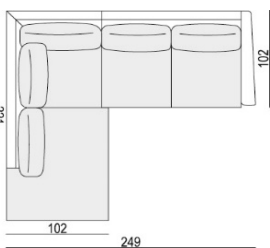
Valid from: 01.02.2024

DIMENSION* with legs H:140mm	DESCRIPTION ARTICLE No	VOL.	WEIGHT	FABRIC USAGE	I	II	III	IV	E	
238/158x102x81/44	SET 1 left - 2 seater r. + chaiselongue l.									
	FC	E1515-5202-2L	2,23	105	12,2	1 027 650	1 111 350	1 190 400	1 274 100	1 585 650
	LCV	E1515-5202-4L	2,23	105	12,2	1 176 450	1 274 100	1 362 450	1 460 100	1 813 500
	COVER	E0515-5202-4	0,08	7	12,2	478 950	576 600	683 550	734 700	1 004 400
238/158x102x81/44	SET 1 right - 2 seater l. + chaiselongue r.									
	FC	E1515-5201-2L	2,23	105	12,2	1 027 650	1 111 350	1 190 400	1 274 100	1 585 650
	LCV	E1515-5201-4L	2,23	105	12,2	1 176 450	1 274 100	1 362 450	1 460 100	1 813 500
	COVER	E0515-5201-4	0,08	7	12,2	478 950	576 600	683 550	734 700	1 004 400
298/158x102x81/44	SET 2 left - 3 seater r. + chaiselongue wide l.									
	FC	E1515-5406-2L	2,43	111	14,3	1 222 950	1 315 950	1 418 250	1 506 600	1 883 250
	LCV	E1515-5406-4L	2,43	111	14,3	1 404 300	1 515 900	1 618 200	1 734 450	2 171 550
	COVER	E0515-5406-4	0,08	8	14,3	567 300	683 550	818 400	869 550	1 195 050
298/158x102x81/44	SET 2 right - 3 seater l. + chaiselongue wide r.									
	FC	E1515-5405-2L	2,43	111	14,3	1 222 950	1 315 950	1 418 250	1 506 600	1 883 250
	LCV	E1515-5405-4L	2,43	111	14,3	1 404 300	1 515 900	1 618 200	1 734 450	2 171 550
	COVER	E0515-5405-4	0,08	8	14,3	567 300	683 550	818 400	869 550	1 195 050
249/221x102x81/44	SET 3 left - 2 seater r. + divan l.									
	FC	E1515-5208-2L	2,45	110	15,9	1 246 200	1 357 800	1 460 100	1 567 050	1 948 350
	LCV	E1515-5208-4L	2,45	110	15,9	1 432 200	1 557 750	1 678 650	1 794 900	2 236 650
	COVER	E0515-5208-4	0,08	9	15,9	576 600	706 800	841 650	906 750	1 241 550
249/221x102x81/44	SET 3 right - 2 seater l. + divan r.									
	FC	E1515-5207-2L	2,45	110	15,9	1 246 200	1 357 800	1 460 100	1 567 050	1 948 350
	LCV	E1515-5207-4L	2,45	110	15,9	1 432 200	1 557 750	1 678 650	1 794 900	2 236 650



Sales Pricelist 2024

UPHOLSTERY: fabric: FC - fix cover or LCV - loose cover with velcro
COMFORTS: lux

currency: EUR

Valid from: 01.02.2024

DIMENSION* with legs H:140mm	DESCRIPTION ARTICLE No	VOL.	WEIGHT	FABRIC USAGE	I	II	III	IV	E
	COVER E0515-5207-4	0,08	9	15,9	576 600	706 800	841 650	906 750	1 241 550
289/221x102x81/44		SET 4 left - 3 seater r. + divan l.							
	FC E1515-5408-2L	2,70	125	17,3	1 348 500	1 464 750	1 581 000	1 697 250	2 106 450
	LCV E1515-5408-4L	2,70	125	17,3	1 553 100	1 683 300	1 808 850	1 943 700	2 431 950
	COVER E0515-5408-4	0,08	10	17,3	632 400	757 950	911 400	976 500	1 343 850
289/221x102x81/44		SET 4 right - 3 seater l. + divan r.							
	FC E1515-5407-2L	2,70	125	17,3	1 348 500	1 464 750	1 581 000	1 697 250	2 106 450
	LCV E1515-5407-4L	2,70	125	17,3	1 553 100	1 683 300	1 808 850	1 943 700	2 431 950
	COVER E0515-5407-4	0,08	10	17,3	632 400	757 950	911 400	976 500	1 343 850
331/180x102/137x81/44		SET 5 left - 3 seater r. + cozy corner l. **							
	FC E1515-5417-2L	2,93	135	18,5	1 404 300	1 520 550	1 650 750	1 767 000	2 204 100
	LCV E1515-5417-4L	2,93	135	18,5	1 608 900	1 753 050	1 892 550	2 027 400	2 534 250
	COVER E0515-5417-4	0,08	11	18,5	655 650	790 500	948 600	1 023 000	1 399 650
331/180x102/137x81/44		SET 5 right - 3 seater l. + cozy corner r. **							
	FC E1515-5416-2L	2,93	135	18,5	1 404 300	1 520 550	1 650 750	1 767 000	2 204 100
	LCV E1515-5416-4L	2,93	135	18,5	1 608 900	1 753 050	1 892 550	2 027 400	2 534 250
	COVER E0515-5416-4	0,08	11	18,5	655 650	790 500	948 600	1 023 000	1 399 650
330/221x102x81/44		SET 6 - divan l. + 2 seater without armrests + divan r.							
	FC E1515-5268-2L	3,69	167	21,2	1 878 600	2 036 700	2 194 800	2 343 600	2 934 150
	LCV E1515-5268-4L	3,69	167	21,2	2 148 300	2 334 300	2 524 950	2 701 650	3 375 900
	COVER E0515-5268-4	0,12	14	21,2	869 550	1 060 200	1 269 450	1 357 800	1 869 300



Sales Pricelist 2024

UPHOLSTERY: fabric: FC - fix cover or LCV - loose cover with velcro
COMFORTS: lux

currency: EUR

Valid from: 01.02.2024

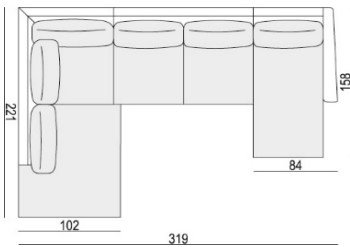
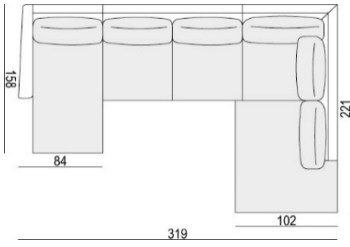
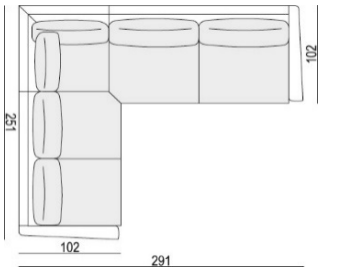
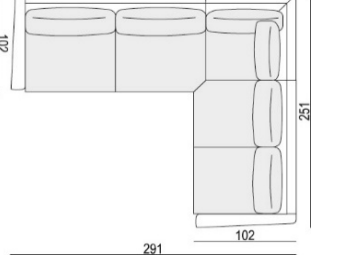
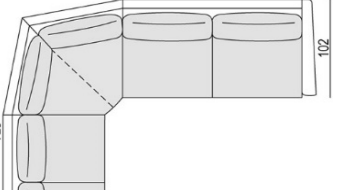
DIMENSION* with legs H:140mm	DESCRIPTION ARTICLE No	VOL.	WEIGHT	FABRIC USAGE	I	II	III	IV	E	
319/221x158/102x81/44										
SET 7 left - chaiselongue r. + 2 seater without armrests + divan l.										
	FC	E1515-5295-2L	3,22	147	19,9	1 650 750	1 785 600	1 911 150	2 046 000	2 557 500
	LCV	E1515-5295-4L	3,22	147	19,9	1 892 550	2 041 350	2 199 450	2 348 250	2 934 150
	COVER	E0515-5295-4	0,12	12	19,9	771 900	934 650	1 106 700	1 181 100	1 618 200
319/221x158/102x81/44										
SET 7 right - chaiselongue l. + 2 seater without armrests + divan r.										
	FC	E1515-5294-2L	3,22	147	19,9	1 650 750	1 785 600	1 911 150	2 046 000	2 557 500
	LCV	E1515-5294-4L	3,22	147	19,9	1 892 550	2 041 350	2 199 450	2 348 250	2 934 150
	COVER	E0515-5294-4	0,12	12	19,9	771 900	934 650	1 106 700	1 181 100	1 618 200
291/251x102x81/44										
SET 8 left - 3 seater r. + corner 90° no.1 + 2 seater l.										
	FC	E1515-5242-2L	2,96	141	20,4	1 581 000	1 706 550	1 846 050	1 980 900	2 459 850
	LCV	E1515-5242-4L	2,96	141	20,4	1 808 850	1 971 600	2 115 750	2 269 200	2 827 200
	COVER	E0515-5242-4	0,10	12	20,4	730 050	897 450	1 064 850	1 143 900	1 567 050
291/251x102x81/44										
SET 8 right - 3 seater l. + corner 90° no.1 + 2 seater r.										
	FC	E1515-5441-2L	2,96	141	20,4	1 581 000	1 706 550	1 846 050	1 980 900	2 459 850
	LCV	E1515-5441-4L	2,96	141	20,4	1 808 850	1 971 600	2 115 750	2 269 200	2 827 200
	COVER	E0515-5441-4	0,10	12	20,4	730 050	897 450	1 064 850	1 143 900	1 567 050
314/274x102x81/44										
SET 9 left - 3 seater r. + corner 90° no.2 ** + 2 seater l.										
	FC	E1515-5293-2L	3,27	145	20,6	1 613 550	1 757 700	1 892 550	2 027 400	2 534 250
	LCV	E1515-5293-4L	3,27	145	20,6	1 860 000	2 013 450	2 180 850	2 329 650	2 906 250

POLLY
LUX

SITS
— comfortable life



home&family

design: SITS

Sales Pricelist 2024

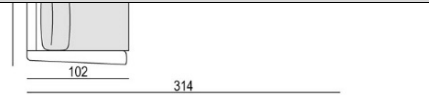
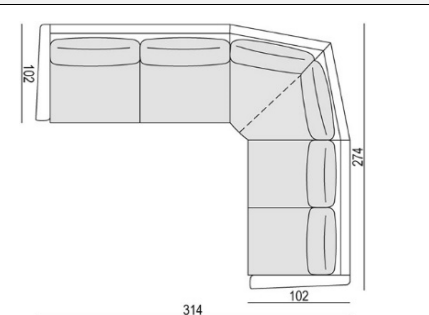
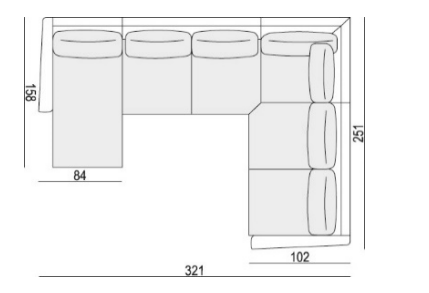
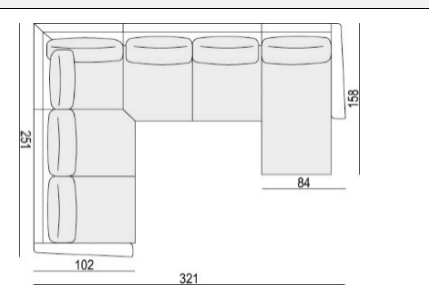
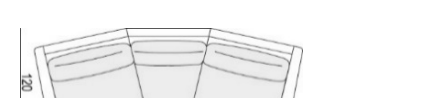
UPHOLSTERY: fabric: FC - fix cover or LCV - loose cover with velcro COMFORTS: lux					Currency: EUR		Valid from: 01.02.2024				
DIMENSION* with legs H:140mm		DESCRIPTION ARTICLE No		VOL.	WEIGHT	FABRIC USAGE	I	II	III	IV	E
		COVER	E0515-5293-4	0,10	12	20,6	753 300	916 050	1 092 750	1 171 800	1 599 600
314/274x102x81/44		SET 9 right - 3 seater l. + corner 90° no.2 ** + 2 seater r.									
		FC	E1515-5491-2L	3,27	145	20,6	1 613 550	1 757 700	1 892 550	2 027 400	2 534 250
		LCV	E1515-5491-4L	3,27	145	20,6	1 860 000	2 013 450	2 180 850	2 329 650	2 906 250
		COVER	E0515-5491-4	0,10	12	20,6	753 300	916 050	1 092 750	1 171 800	1 599 600
321/251x158/102x81/44		SET 10 left - 2 seater r. + corner 90° no.1 + 2 seater without armrests + chaiselongue l.									
		FC	E1515-5289-2L	3,48	163	24,1	1 883 250	2 027 400	2 190 150	2 334 300	2 915 550
		LCV	E1515-5289-4L	3,48	163	24,1	2 171 550	2 334 300	2 520 300	2 683 050	3 343 350
		COVER	E0515-5289-4	0,14	14	24,1	869 550	1 060 200	1 255 500	1 348 500	1 855 350
321/251x158/102x81/44		SET 10 right - 2 seater l. + corner 90° no.1 + 2 seater without armrests + chaiselongue r.									
		FC	E1515-5288-2L	3,48	163	24,1	1 883 250	2 027 400	2 190 150	2 334 300	2 915 550
		LCV	E1515-5288-4L	3,48	163	24,1	2 171 550	2 334 300	2 520 300	2 683 050	3 343 350
		COVER	E0515-5288-4	0,14	14	24,1	869 550	1 060 200	1 255 500	1 348 500	1 855 350
244/115x102x85/44		SET 13 - armchair l. + corner 30° + armchair r.									
		FC	E1515-5052-2L	1,77	101	12,5	1 171 800	1 255 500	1 353 150	1 446 150	1 794 900
			E1515-5052-4L	1,77	101	12,5	1 353 150	1 455 450	1 553 100	1 655 400	2 069 250
		COVER	E0515-5052-4	0,07	8	12,5	544 050	660 300	781 200	837 000	1 143 900
283/120x102x85/44		SET 14 - armchair wide l. + corner 30° + armchair wide r.									
		FC	E1515-5152-2L	2,34	117	15,5	1 432 200	1 548 450	1 655 400	1 757 700	2 190 150
		LCV	E1515-5152-4L	2,34	117	15,5	1 641 450	1 780 950	1 892 550	2 022 750	2 501 700

POLLY
LUX

SITS
— comfortable life



home&family

design: SITS

Sales Pricelist 2024

UPHOLSTERY: fabric: FC - fix cover or LCV - loose cover with velcro COMFORTS: lux					Currency: EUR		Valid from: 01.02.2024				
DIMENSION* with legs H:140mm	DESCRIPTION ARTICLE No	VOL.	WEIGHT	FABRIC USAGE	I	II	III	IV	E		
	COVER E0515-5152-4	0,07	9	15,5	669 600	799 800	953 250	1 009 050	1 395 000		

*Explicit +/- 2 cm tolerance of all elements sizes

**This element may have a stitching on the seat cushion. Ask your representative for more details.